

INVITATION FOR TENDER FOR SUPPLY OF SOLAR PV SYSTEMS

Sealed tender offers are invited in two separate sealed covers (Technical and Commercial offers) from eligible manufacturers/suppliers or their direct Indian agents for the supply of the following equipment. Vendors may quote for all the items or one or more items

SOLAR PV SYSTEMS

Please send offers, **ALONG WITH DESCRIPTIVE CATALOGUE/ BROCHURE**. The validity of the bid should be at least four months (120 days) or more from the date of the opening of this tender. Please ensure that your quotation reaches not later than **01.08.2018 at 15:00 Hrs** at the following address:

Prof. J.N. Roy,
ATDC & School of Energy Science and Engineering,
Indian Institute of Technology Kharagpur, Kharagpur, West Bengal– 721 302, India,

Earnest money of **Rs. 4000/-** is to be deposited in the form of Account Payee Demand Draft in favor of IIT Kharagpur, payable at Kharagpur, India. Any bid which is not accompanied with an EMD shall be summarily rejected. Earnest money deposited will be forfeited if the tenderer withdraws or amends its tender or impairs or derogates from the tender in any respect within the period of validity of its tender. No interest will be paid on the earnest money of the unsuccessful bidders.

Tender Reference	IIT/SRIC/ATDC/ UIR /JNR/2018/EQ-10,Dated: 27.06.2018
Price of Tender Document	NIL
Time and Date for Pre-bid meeting	18.07.2018 at 11:00 Hrs. (Indian Time)
Last Date and Time for submitting the tender document	01.08.2018 at 15:00 Hrs. (Indian time)
Time and Date of Opening of Technical Bids	01.08.2018 at 16:00 Hrs. (Indian time)
Place of Opening Tender	Advanced Technology Development Centre, Indian Institute of Technology Kharagpur, Kharagpur, West Bengal – 721 302, India.
Address of Communication	As stated above
Contact Telephone Numbers	+91- 3222 - 282228
E-mail	jnroy@atdc.kgp.ernet.in

Technical specification of the Solar PV system

Table I described the type of Grid Connected Solar PV systems to be installed. The schematic of the entire system to be installed is shown in the schematic diagram.



(Code: UKICERI/PVSYSTEMS/Schematic). The details of each system are discussed subsequently.

System Description

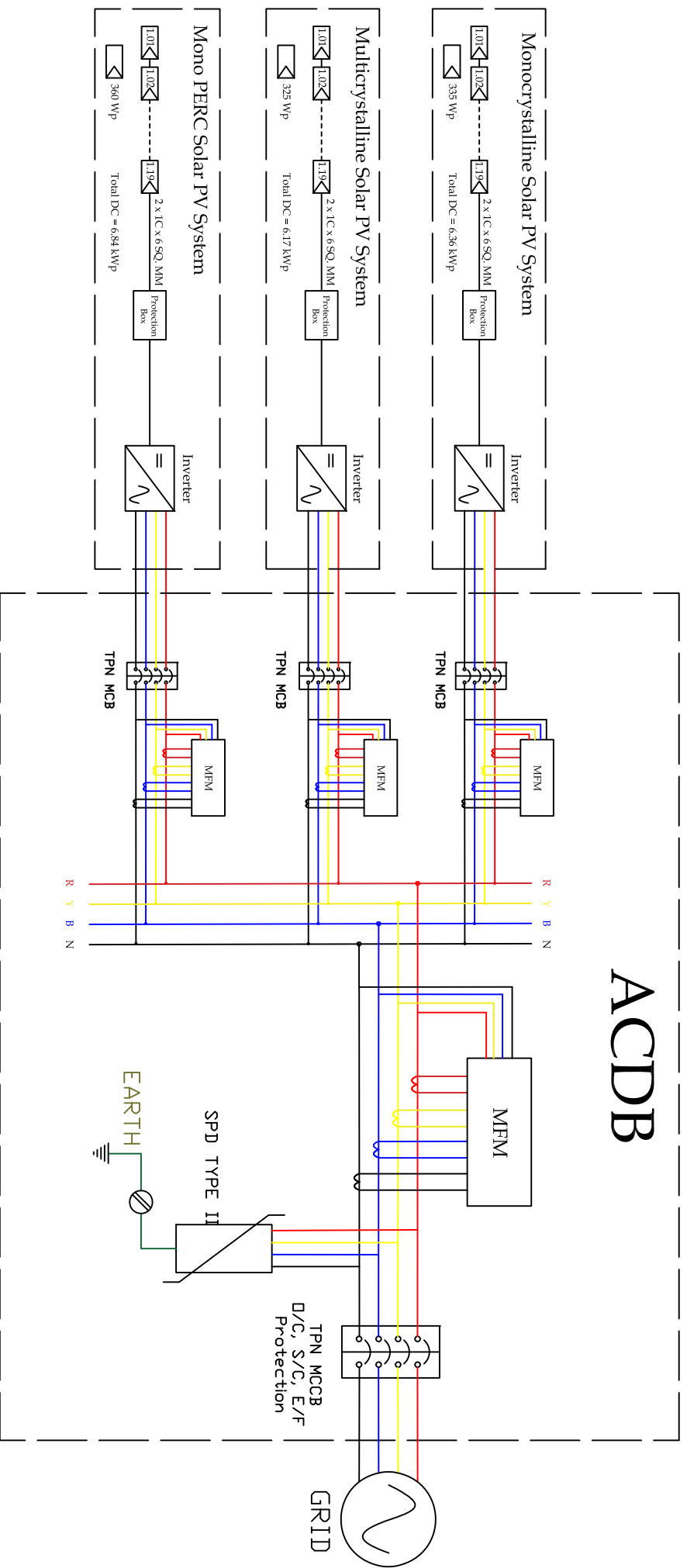
Sl. No.	Technology	Capacity
1	Mono c-Si Grid Connected Solar PV System	6.36 kW_p
2	Multi c-Si Grid Connected Solar PV System	6.17 kW_p
3	Mono PERC Grid Connected Solar PV System	6.84 kW_p



ACDB

TITLE - Schematic Diagram	DRAWN BY - IITKGP	REV - 0.00	 	
DRG CODE - UKICERI/PVSYSTEMS/Schematic	APPROVED BY -	SIGN -		
PROJECT - UKICERI (UR)	DATE - 23 . 06. 2018	INDIAN INSTITUTE OF TECHNOLOGY KHARAGPUR		

Design Guidelines-

In all three PV systems, there will be a single string of Solar Modules having 19 nos. of modules, the inverter should have a Maximum DC Input Voltage of 1000 V(or higher), MPP Voltage range 300 V (or lower) to 800 V (or higher).

Given below are the specifications –

PV Modules-

PV Module Type	Wattage	Nos.
Mono c-Si	335W	19
Multi c-Si	325W	19
Mono PERC	360W	19

Inverter specifications–



Rated DC Input Power	5.8 to 7 kW
Number of MPPT/ Input string	1
Absolute maximum DC input voltage	1000 V
MPPT input DC voltage range	320 to 800 V
AC grid connection type	3 phase, 4W+ PE
Rated AC grid voltage	400 V
Rated output frequency	50 Hz
Nominal power factor and adjustable range	> 0.995, adj. \pm 0.9
Total current harmonic distortion	< 2%
Anti-islanding protection	According to local standard
Remote Monitoring	Ethernet expansion card option with integrated web server and remote monitoring capability via web portal (Modbus/TCP supported)

Other specifications-

AJB	Refer to drawing Code: UKICERI/PVSYSTEMS/Protection Box
Cable (Sizing/Selection)	1. Solar Grade, UV protected 1.8 kV XLPE insulated DC Cable (Manufacturers- Lapp, Leoni, Polycab/ Equiv.) 2. Armored cable between inverter and ACDB and from ACDB to GRID 3. Proper cable size should be selected considering length, temperature, etc. into account, according to NEC/IEC/IS/IEEE Rules. Cable losses calculation should be submitted.
Bus bar Sizing	Proper bus bars size should be selected considering SC Capacity, temperature, etc. into account, according to NEC/IEC/IS/IEEE Rules. Calculation should be submitted.

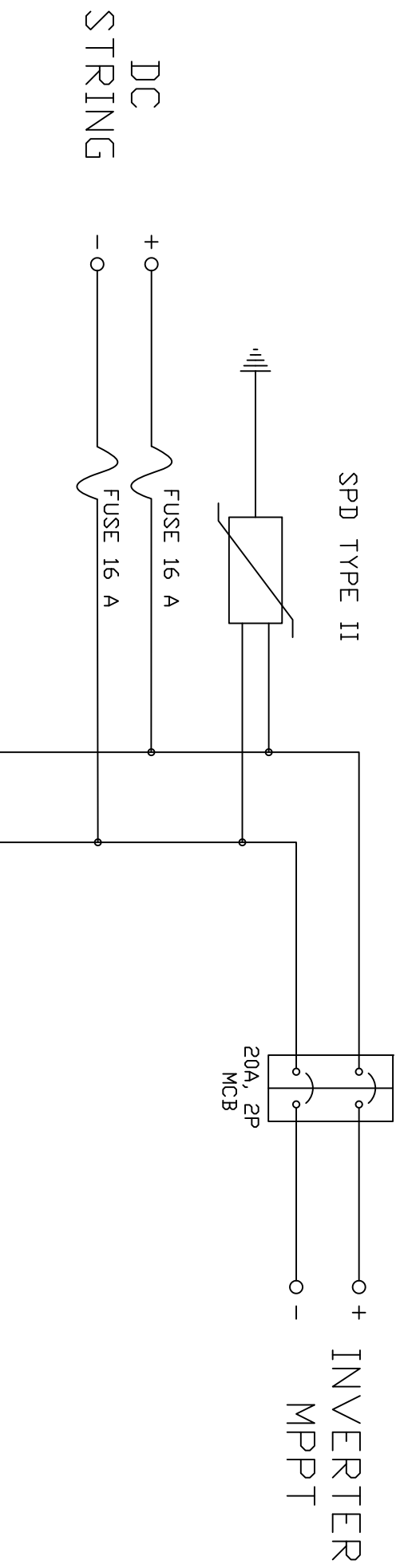
Cable trays	Perforated cable trays, ladder type cable trays- Galvanized
Nut bolts	SS 304
Cable Tags, Ferules & Danger Sign Board	Yes
Ingress Protection	IP 65 for AJB and any other equipment exposed in outdoor
Earthing	Earth resistance should be less than 1 ohm, Earth strips to be laid on insulators.
Gland	Glands of proper sizes to be used for ACDB , AJB.
Lightning arrestor	Should cover the whole plant area. ESE Lightning arrestor.
Structures	Design and drawings of structures are to be first approved before construction
	Minimum distance between modules and floor should not be less than 60cm
	Structures should be strong enough and designed such that it can withstand wind upto 150 <i>kmph</i>
	Thickness of vertical pole (legs) - 6mm (50x50x6), purlin , rafter- 5mm. Bracing are to be provided for additional stability of the structure whenever required. STAAD Pro report file to be submitted before the commencement of work.
	Galvanization thickness of module mounting structure should be 120 MICRON
Shading	The PV systems will be installed at 100% shadow free area. Shadow Analysis report in 3D simulation tool like Google Sketchup/ equiv to be submitted before the commencement of work.
Module Cleaning Arrangement	Water tank and piping arrangement for module cleaning.
Module & Inverter Certifications	Must have latest IEC Certifications.



TITLE - Protection Box	DRAWN BY - IITKGP	REV - 0.00	
DRG CODE -UKICERI/PVSYSTEMS/Protection Box	APPROVED BY -	SIGN -	
PROJECT - UKICERI (UIR)	DATE - 23 . 06. 2018	 	

GENERAL TERMS & CONDITIONS

PLEASE SPECIFICALLY INDICATE THE FOLLOWING POINTS IN YOUR QUOTATIONS AND COMPLY THE TERMS AS MENTIONED HEREUNDER: -

1. TENDERS ARE INVITED COMPLYING THE REQUIREMENT FOR TENDERS AS DETAILED IN THE TENDER SPECIFICATION TO BE SUBMITTED IN THE COMPANY'S / FIRM'S LETTERHEAD NEATLY PRINTED / TYPED DULY SIGNED BY AUTHORIZED PERSON WITH THE SEAL OF THE BIDDERS. ALL ENVELOPES CONTAINING THE TENDER SHOULD BE PROPERLY SEALED. SEPARATE ENVELOPES SHOULD BE USED FOR TECHNICAL AND PRICE BID AND INDICATION TO THEIR EFFECT MAY PLEASE BE SUPERSCRIBED ON THE ENVELOPE.

THE FOLLOWING DOCUMENTS ARE REQUIRED FROM THE INDIAN AGENTS OF FOREIGN FIRMS:

- 1.1 FOREIGN PRINCIPAL'S PROFORMA INVOICE INDICATING THE COMMISSION PAYABLE TO THE INDIAN AGENT AND NATURE OF AFTER SALES SERVICE TO BE RENDERED BY THE INDIAN AGENT.
- 1.2 COPY OF THE AGENCY AGREEMENT WITH THE FOREIGN PRINCIPAL INDICATING THE NATURE OF AFTER SALES SERVICES, PRECISE RELATIONSHIP BETWEEN THEM AND THEIR MUTUAL INTEREST IN THE BUSINESS.
- 1.3 PLEASE ENCLOSE THE DOCUMENT(S) RELATED TO THE ENLISTMENT OF THE INDIAN AGENT WITH DIRECTOR GENERAL OF SUPPLIES & DISPOSALS (DGS & R) UNDER THE COMPULSORY REGISTRATION SCHEME OF MINISTRY OF FINANCE.
2. TECHNICAL CATALOGUE/LEAFLET SHOULD BE ENCLOSED WITHOUT FAIL. PROVIDE COMPLIANCE STATEMENT WITH RESPECT TO THE TECHNICAL SPECIFICATIONS MENTIONED ABOVE.
3. PLEASE CONFIRM WHETHER YOU ARE AUTHORISED TO QUOTE ON BEHALF OF YOUR PRINCIPALS AND IF SO, PLEASE ENCLOSE A COPY OF SUCH AUTHORISATION WITH YOUR QUOTATION.
4. **PRICE BIDS FOR FOREIGN FIRMS:** PRICES ARE TO BE QUOTED ON 'EX-WORKS' DULY PACKED OR ON "FCA/FOB" INTERNATIONAL PORT" BASIS AND ALSO INCLUDING AGENCY COMMISSION PAYABLE TO YOUR INDIAN AGENTS, IF ANY SHOWING CLEARLY THE FOLLOWING BREAK UP: -

- I) EX-WORKS PRICE
- II) PACKING & FORWARDING
- III) FREIGHT
- IV) ANY OTHER RELEVANT EXPENSES.
- V) TAXES PAYABLE BY THE INSTITUTE

INSURANCE WILL BE PAID BY OUR INSTITUTE SEPARATELY AND SHOULD NOT FORM PART OF THE QUOTED PRICE.

PRICE BIDS FOR INDIAN FIRMS: PRICES ARE TO BE QUOTED ON F.O.R., IIT KHARAGPUR, ON DOOR DELIVERY BASIS CLEARLY SHOWING THE BREAK UP.

- 5. **PERIOD OF VALIDITY:** BIDS SHALL REMAIN VALID FOR ACCEPTANCE FOR A PERIOD OF 120 DAYS FROM THE DATE OF OPENING.
- 6. INDIAN AGENTS ADDRESS AND PERCENTAGE OF AGENCY COMMISSION INCLUDED IN ABOVE F.O.B./EX-WORKS PRICE. (THIS WILL BE PAID TO THE INDIAN AGENTS IN INDIAN RUPEES ONLY AND NOT IN **FE**). PLEASE ENCLOSE COPY OF AGENCY AGREEMENT ENTERED INTO WITH YOUR PRINCIPALS INDICATING THE NATURE OF AFTER SALES SERVICES OF INDIAN AGENTS, PRECISE RELATIONSHIP & MUTUAL INTEREST IN THE BUSINESS.
- 7. **MEASUREMENTS/WEIGHT:** NETT/GROSS OF THE CONSIGNMENT. IN CASE OF AN ORDER, YOU SHALL USE AIR WORTHY PACKAGE (AS APPLICABLE) DULY CERTIFIED WITH DOCUMENTS – PLYTO – SANITARY CERTIFICATE (AS PER QUARANTINE ORDER 2003).
- 8. **SCOPE OF SUPPLY:** SHOULD INCLUDE FREE INSTALLATION AND COMMISSIONING
- 9. **PAYMENT TERMS FOR FOREIGN FIRMS**
 - A) 90% PAYMENT THROUGH SIGHT DRAFT/FORIGN DEMAND DRAFT/LC (EXCEPTIONAL CASES)/SWIFT TELE TRANSFER AFTER RECEIPT OF STORE IN GOOD ORDER AND CONDITION AND 10% AFTER SUCCESSFUL INSTALLATION & COMMISSIONING.
 - B) BANK CHARGES ON LC/SD (WITHIN INDIA APPLICANT ACCOUNT AND OUTSIDE INDIA TO BENEFICIARY ACCOUNT).

PAYMENT TERMS FOR INDIAN FIRMS

- A) 90% PAYMENT THROUGH CROSSED ACCOUNT PAYEE CHEQUE / ELECTRONIC TRANSFER AFTER RECEIPT OF STORE IN GOOD ORDER AND CONDITION AND 10% AFTER SUCCESSFUL INSTALLATION & COMMISSIONING.

B) ENSURE MENTIONING

- i) BANK DETAILS OF THE BENEFICIARY, VAT NO., SERVICE TAX NO. AND PAN NUMBER
 - ii) FULL NAME AND ADDRESS OF THE BENEFICIARY ON WHOM ORDER HAS TO BE PLACED
10. WHETHER ANY EXPORT LICENCE IS REQUIRED FROM YOUR GOVERNMENT, IF SO, PLEASE CONFIRM WITH DETAILS.
 11. COUNTRY OF ORIGIN OF THE GOODS IS TO BE MENTIONED.
 12. THE INSTITUTE SHALL PROVIDE THE CONCESSIONAL CUSTOMS DUTY AND EXCISE DUTY EXEMPTION CERTIFICATE AS PER GOVT. NOTIFICATION NO. 51/96 CUSTOMS DATED: 23.07.1996 AND CENTRAL EXCISE DUTY EXEMPTION IN TERMS OF GOVT. NOTIFICATION NO. 10/97 – CENTRAL EXCISE DATED: 01.03.1997 AS AMENDED FROM TIME TO TIME.
 13. **LIQUIDATED DAMAGES:** THE STORES SHOULD BE DELIVERED / DISPATCHED TO DESTINATION AND READY FOR OPERATION NOT LATER THAN THE DELIVERY DATE SPECIFIED. IF THE SUPPLIER FAILS TO DELIVER ANY OR ALL THE STORES OR PERFORM THE SERVICE BY THE SPECIFIED DATE, LIQUIDATED DAMAGES AT 1% PER MONTH OR PART THEREOF IN RESPECT OF THE VALUE OF STORES WILL BE DEDUCTED FROM THE CONTRACT PRICE SUBJECT TO A MAXIMUM OF 5%. ALTERNATIVELY, THE ORDER WILL BE CANCELLED AND THE UNDELIVERED STORES PURCHASED FROM ELSEWHERE AT THE RISK AND EXPENSE OF SUPPLIER.
 14. **PATENT RIGHTS:** THE SUPPLIER SHALL INDEMNIFY THE PURCHASE AGAINST ALL THIRD PARTY CLAIMS OF INFRINGEMENT OF PATENT, TRADEMARK OR INDUSTRIAL DESIGN RIGHTS ARISING FROM USE OF THE GOODS OR ANY PART THEREOF IN INDIA.
 15. ONLY THOSE BIDDERS WHO'S BIDS HAVE BEEN TECHNICALLY FOUND ACCEPTABLE WILL ONLY BE INVITED FOR PARTICIPATION IN THE PRICE BID.
 16. THOSE BIDDERS WHO DO NOT RECEIVE ANY COMMUNICATION FOR PARTICIPATION IN PRICE BID OPENING MEETING MAY PRESUME THAT THEIR BID HAS NOT BEEN ACCEPTED BY THE INSTITUTE.
 17. CONDITIONAL OFFER WILL NOT BE ACCEPTED.
 18. LATE TENDERS I.E. TENDER RECEIVED AFTER THE DUE DATE AND TIME OF SUBMISSION AS MENTIONED ABOVE SHALL NOT BE ACCEPTED.
 19. BIDDERS TO ENCLOSE THE FOLLOWING DOCUMENTS: -

A) CURRENT INCOME TAX AND SALES TAX CLEARANCE CERTIFICATES (VAT No.), SERVICE TAX NO. AND PAN NO.

B) BANKER'S SOLVENCY CERTIFICATE

C) SUMMARY OF AUDITED STATEMENT OF ACCOUNTS FOR THE LAST THREE YEARS TO BE ENCLOSED AND FINANCIAL HIGHLIGHTS AND THE KEY PERFORMANCE DURING THE LAST THREE QUARTERS TO BE ENCLOSED AS PER FORMAT: -

COMPANY'S KEY PERFORMANCE

DESCRIPTION	JAN. TO MARCH	APRIL TO JUNE	JULY TO SEPT.
GROSS REVENUE			
PROFIT BEFORE TAX			
PROFIT AFTER TAX			
RETURN ON INVESTED CAPITAL (ROIC)			

D) CUSTOMER SATISFACTION CERTIFICATE FROM ONE SUCH ORGANIZATION IS TO BE ATTACHED WITH THE TECHNICAL BID AND PRICE BID.

E) NAME AND ADDRESS OF MINIMUM THREE CLIENTS TO WHOM SUCH EQUIPMENT HAVE BEEN SUPPLIED SHOULD BE MENTIONED.

20. **WARRANTY / GUARANTEE:** THIS COMPREHENSIVE WARRANTY / GUARANTEE SHALL REMAIN VALID FOR **36 MONTHS** AFTER THE GOODS (OR ANY PORTION THEREOF AS THE CASE MAY BE) HAVE BEEN DELIVERED AND COMMISSIONED TO THE FINAL DESTINATION.

21. THE INSTITUTE DOES NOT BIND ITSELF TO OFFER ANY EXPLANATION TO THOSE BIDDERS WHO'S TECHNICAL BID HAS NOT BEEN FOUND ACCEPTABLE BY THE EVALUATION COMMITTEE OF THE INSTITUTE.

ALL TENDERS (UNLESS OTHERWISE SPECIFIED) ARE TO BE SUBMITTED / HANDED OVER TO **Dr. J.N. Roy, Professor, ATDC & School of Energy Science and Engineering, INDIAN INSTITUTE OF TECHNOLOGY KHARAGPUR, Kharagpur, West Bengal - 721 302** AND ACKNOWLEDGEMENT TO BE OBTAINED.

IMPORTANT

1. IIT Kharagpur authority may accept or reject any or all the bids in part or in full without assigning any reason and does not bind itself to accept the lowest bid. The Institute at its discretion may change the quantity / upgrade the criteria / drop any item or part thereof at any time before placing the Purchase Order.
2. Promptly make arrangements for repair and / or replacement of any damaged item (s) irrespective of settlement of claim.
3. In case of any dispute, the decision of the Institute authority shall be final and binding on the bidders.
4. For any query pertaining to this bid document correspondence may be addressed to **Dr. J.N. Roy, Professor, ATDC & School of Energy Science and Engineering**, at the address mentioned above.

LAST DATE FOR SUBMISSION OF SEALED BIDS: 01.08.2017

- 1) Please Note that the Institute remains closed during Saturdays & Sundays and all specified government holidays.
 - 2) Fax, e-mail Tender will not be accepted.
 - 3) The General Terms and Conditions as stated above relate to supply of stores / equipment /assets etc. and for specific service other terms and conditions of the Institute will apply.
-